

NET9000 Fieldbus Connections

912x-IS FISCO power supplies



Declaration of Conformity

A printed version of the Declaration of Conformity has been provided separately within the original shipment of goods. However, you can find a copy of the latest version at <http://www.mtl-inst.com/certificates>

CONTENTS

	DECLARATION OF CONFORMITY	II
1	ABOUT THIS MANUAL	1
	1.1 Product description	1
2	INSTALLATION	1
	2.1 Mounting & enclosure requirements	1
	2.2 Mounting	2
	2.3 Signal and power connections	3
	2.5 Making connections	3
	2.6 Finishing	3
3	SETUP AND TESTING	4
	3.1 Switches	4
	3.2 Testing	4
	3.3 Tag labelling	4
4	MAINTENANCE	4
	4.1 Routine maintenance	4
	4.2 Enclosures	4
5	Ancillary FIELDBUS equipment	5
	5.1 Fieldbus terminator	5
	5.2 Spur connectors	5
	5.3 Mounting and connection	6
6	Appendix A - ATEX information	7

IMPORTANT NOTICE

The user's attention is drawn to the important safety information provided in Appendix A.

This page left intentionally blank



1 ABOUT THIS MANUAL

The purpose of this manual is to provide the user with information on the installation, connection, test and maintenance of the MTL912X range of Fieldbus Intrinsically Safe COnccept (FISCO) power supplies.

"Cautionary Note: In common with all other electrical apparatus installed in hazardous areas, this apparatus must only be installed, operated and maintained by competent personnel. Such personnel shall have undergone training, which included instruction on the various types of protection and installation practices, the relevant rules and regulations, and on the general principles of area classification. Appropriate refresher training shall be given on a regular basis. [See clause 4.2 of EN 60079-17].

This instruction manual supplements the requirements of nationally accepted codes of practice, for example, IEC/EN 60079-11 in Europe and the National Electrical Code, combined with ANSI/ISA-RP 12.6 in the USA. All installations should comply with the relevant sections of these codes.

In addition, particular industries or end users may have specific requirements relating to the safety of their installations, and these requirements should also be met".

1.1 PRODUCT DESCRIPTION

The 9121-IS and 9122-IS are fieldbus repeater isolators that can relay fieldbus signals between a host in a safe, or Zone 2 / Division 2 hazardous area and IS field devices in a Zone 1 / Division 1 hazardous area. They provide DC power and an impedance terminator to the IS fieldbus and also, if required, to the host fieldbus.

1.1.1 Model 9121-IS

This can provide 120mA current, which typically would power at least six field devices in IEC Gas Group IIC* environments, where a typical device is considered to have a current consumption of 20mA.

1.1.2 Model 9122-IS

For Gas Group IIB† environments the 9122-IS can provide a higher output current of 265mA, which will power at least twelve field devices rated at 20mA.

* Equivalent to Class I, Gas Groups A and B in N. America

† Equivalent to Class I, Gas Group C in N. America

2 INSTALLATION

2.1 MOUNTING & ENCLOSURE REQUIREMENTS

2.1.1 General

These power supplies may be mounted in safe areas, Zone 2 or Division 2 hazardous areas but, wherever they are located, the mounting conditions must:

- maintain safe segregation distances for units and IS wiring.
- prevent any form of pollution that could compromise the operation, or safety of the unit. For example, an unpolluted location or a suitable enclosure could be chosen.
- provide an adequate level of mechanical protection. This can be achieved by selecting a protected location, a suitable enclosure, or a combination of both.
- ensure that all cable entries and connections are secure by making provision for the careful routing and securing of all cables.
- provide adequate security against unauthorised interference.
- ensure that the permitted ambient temperature range of the units (-40°C to $+70^{\circ}\text{C}$) is not exceeded. Power dissipation within the enclosure and the use of shading against direct sunlight should be considered.

2.1.2 Outdoor mounting

Where power supplies are mounted in outdoor locations then the use of a suitably approved enclosure is recommended. For Zone 2 locations, Ex e or Ex n enclosures are an economic solution that satisfy the minimum acceptable criteria of a 7Nm impact test and IP54 ingress protection. However, in some locations a higher degree of ingress protection or corrosion resistance may be necessary or desirable. The emphasis should be placed on the suitability for the application rather than the extent of certification.

2.1.3 Wiring segregation

The intrinsically safe wiring must be segregated from all other wiring. When units are mounted in several parallel rows it is common practice for alternate rows to be reversed, so that the wiring can share common looms or trunking. Because this involves alternate rows being mounted "upside down", this technique may be used only when the units are NOT required to operate at the maximum ambient temperature (for the reasons stated in the previous paragraph).

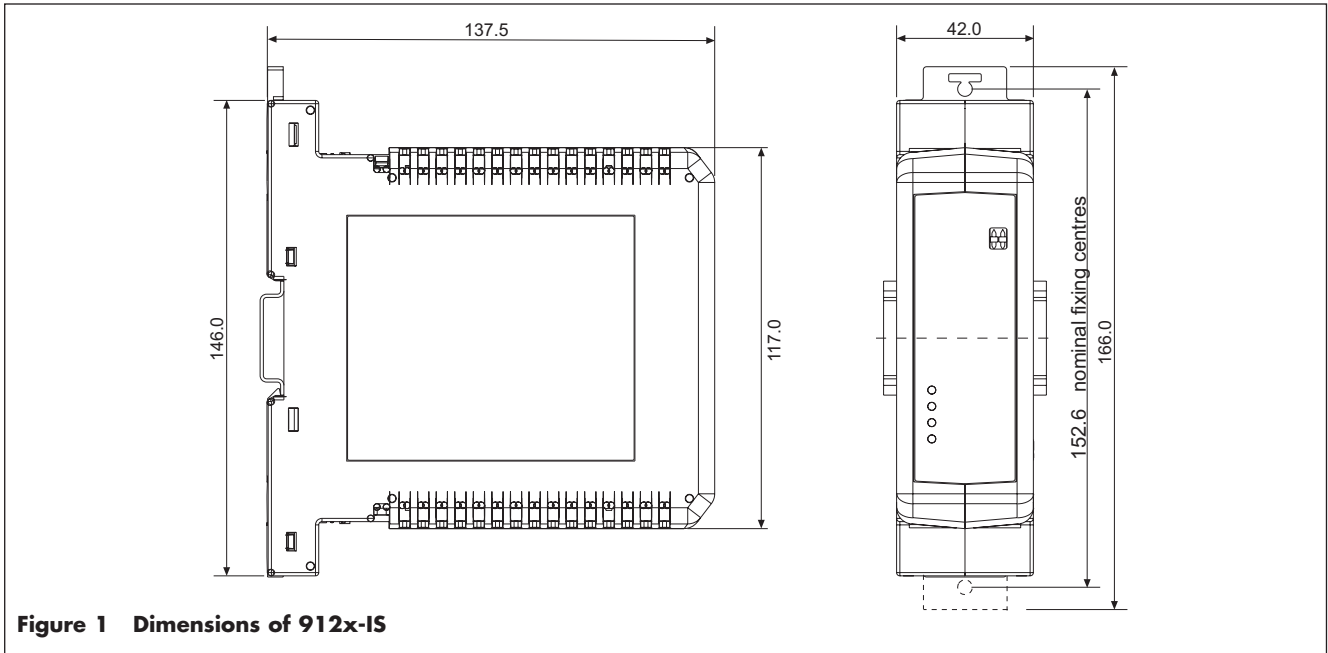

Figure 1 Dimensions of 912x-IS

2.2 MOUNTING

2.2.1 Orientation

The 912x range of power supplies can be mounted on type T35 [top hat] DIN-rail, or surface mounted. In either case, the orientation must allow air to be naturally convected through the unit to achieve the maximum cooling effect. To make use of the full temperature range specified for a unit it must be mounted on a vertical surface with the switches at the top - as shown in the right-hand part of Figure 1.

2.2.2 Mounting FISCO power supplies on DIN rail

Press the unit onto the DIN rail (type T35) as shown in figure 2, with the intrinsically safe (IS) terminals (marked with blue labels) facing the IS field wiring connections.



Figure 2 - Mounting on DIN rail

To remove a unit from the rail, insert a screwdriver blade into the clip as shown in figure 3 and lever the clip gently outwards; pivot the isolator off the rail.

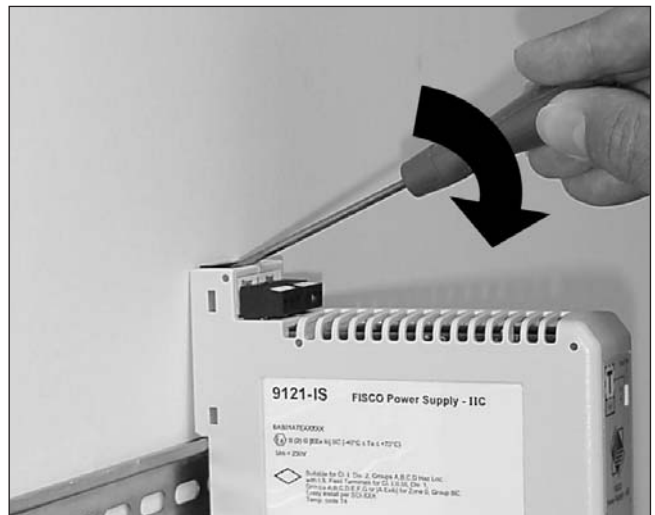

Figure 3 - Removing from DIN rail

2.2.3 Surface mounting FISCO power supplies

To surface mount a 912X - IS power supply, ease out the DIN rail clips at each end (in the manner shown in Figure 3) to reveal mounting brackets, which contain clearance holes for M4 screws or bolts.

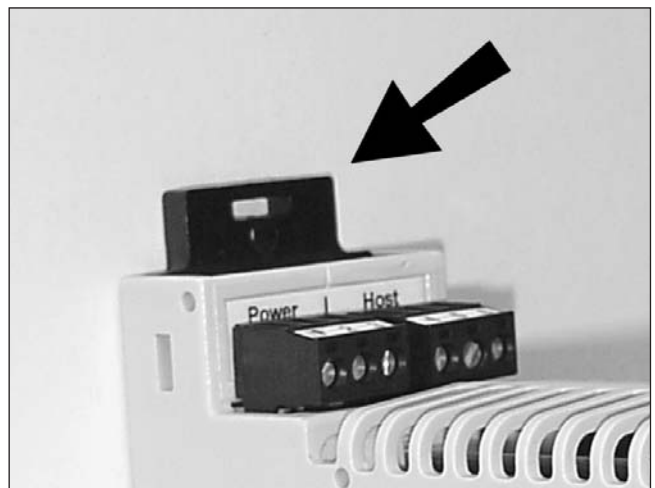

Figure 4 - Surface mounting brackets

2.3 SIGNAL AND POWER CONNECTIONS

2.4.1 General

All units have removable signal and power plugs. The plugs can be supplied with either screw-clamp (912X-IS-PS) or sprung cage-clamp (912X-IS-PC) terminals as shown in figure 5.

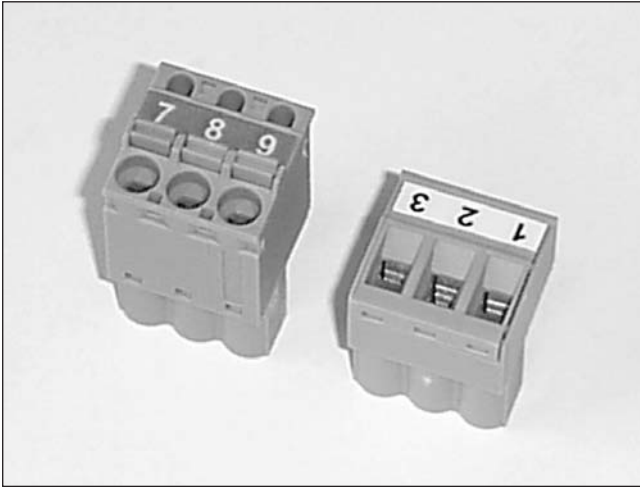

Figure 5 - Spring clamp and screw clamp plugs.

The user can decide whether it will be easier to wire the power supply with the connector plugs in-situ, or to remove them. If the connectors are removed for wiring, ensure that the correct one is being wired; the plugs use a mechanical key system to prevent accidental cross connection - they are NOT interchangeable.

Ensure that enough cable is provided to permit future removal of the plugs for maintenance or replacement.

To remove a connector plug insert a screwdriver blade behind it as shown in figure 6 and lever the connector gently outwards.

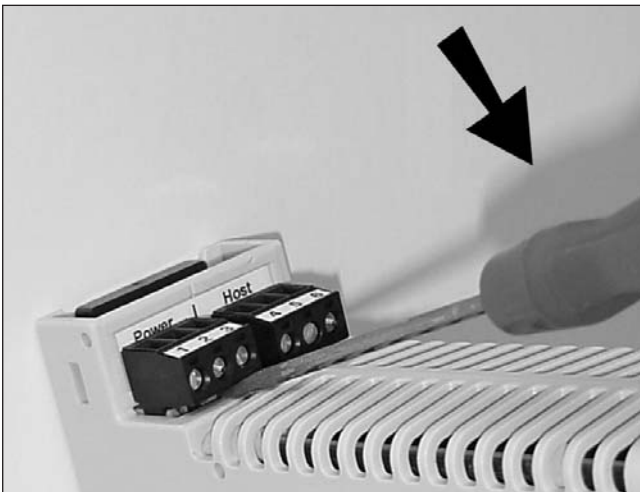

Figure 6 - Removing power and signal connectors

The conductors or ferrules used with these connectors should be between 14 and 24 AWG (1.6 and 0.5mm dia) in size. If two large conductors need to be accommodated, e.g. two -ve connections on the Power connector, then a twin ferrule should be used.

2.4.2 Host and IS fieldbus connections

The block diagram (Figure 7) shows terminals 5 and 8 marked with an 'S'. This indicates a termination point for the fieldbus cable screen. These are termination points only, with no internal connection.

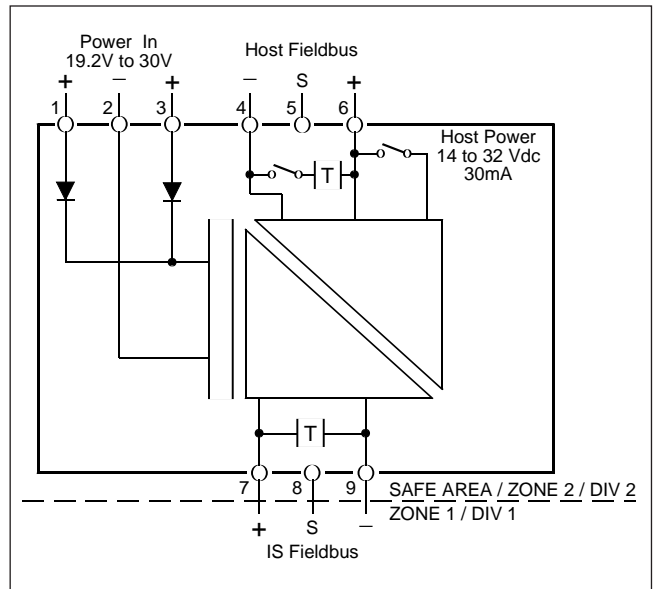

Figure 7 - Power supply block diagram

2.4.3 Power connection

The 912X-IS units can accommodate two power inputs for applications that require redundancy. Internal steering diodes ensure correct power sharing.

Connect supplies as indicated below.

		+ ve to terminal	-ve to terminal
Single power input	Power 1	1 or 3	2
	Power 2	3	2
Redundant power	Power 1	1	2
	Power 2	3	2

2.5 MAKING CONNECTIONS

2.5.1 Screw clamp connector

- Strip back the insulation of conductors (7mm - recommended strip length - See note).
- Check the terminal assignments, as indicated on the side label of the unit.
- Insert conductor into connector and tighten screws.

2.5.2 Spring (cage) clamp connector

- Strip back the insulation of conductors (10 mm - recommended strip length - See note).
- Check the terminal assignments, as indicated on the side label of the unit.
- Press screwdriver blade into groove on spring clamp; fully insert conductor; remove screwdriver.

Note If the wires are to be fitted with crimp ferrules consult ferrule manufacturer's recommendation.

2.6 FINISHING

Wire up individual FISCO power supplies in accordance with wiring schedules. Power supply connections can be onward linked from one power plug to the next (i.e. 'daisy-chained').

Segregate intrinsically safe wiring from other wiring into separate trunking or looms wherever possible to avoid errors and maintain a tidy installation.

3 SETUP AND TESTING

3.1 SWITCHES

Two switches are provided on the front face of the power supply, located in the top right-hand corner. Operation of these switches requires the use of a small screwdriver, or similar.

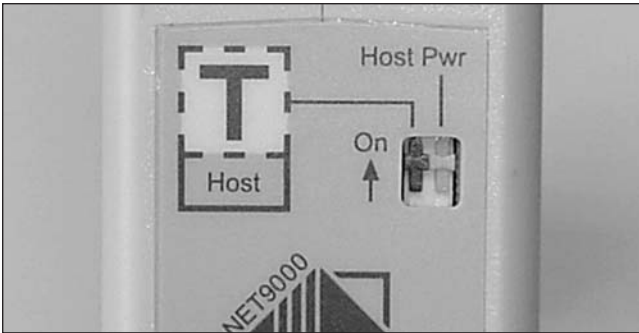

Figure 8 - Host power supply and host trunk terminator switches

3.1.1 "Host Pwr" switch

Some host fieldbus I/O cards need to draw 10–20mA of current from the fieldbus in order to operate. If this is required, the "Host Pwr" switch on the 912X-IS unit should be set to the ON position. The voltage provided on the fieldbus is in the range 14–32 V dc, at a maximum current of 30 mA.

IMPORTANT - If more than one 912X-IS power supply is connected to the same host segment, **only one** of them should have its "Host Pwr" switched to the ON position. All the others on this same host segment must have their "Host Pwr" switch set to OFF.

3.1.2 Terminator switch

A terminator is required at each end of a fieldbus segment. If a single 912X-IS power supply is connected to the remote end of a host segment, a terminating impedance must be applied by setting its "T (Host)" switch to ON. A fieldbus terminator must also be applied, or connected, at the host end of the segment.

IMPORTANT - If more than one 912X-IS power supply is connected to the same host segment, **only one** of them should have its "T (Host)" terminator switch set to ON. All the others on this same host segment must have their "T (Host)" switch set to OFF.

3.2 TESTING

The following checks refer to the LED indicators (see Figure 9)

Power LED (green)

This should normally be ON. If not, check the power connections.

Fault LED (red)

This should normally be OFF. If it is ON, it indicates:

- (a) a short circuit on the IS fieldbus or,
- (b) excessive transmitter load, i.e. too many field devices.

Host or IS LED (yellow)

Both of these should normally be ON.

OFF indicates a permanent comms error and flashing indicates an occasional communications error.

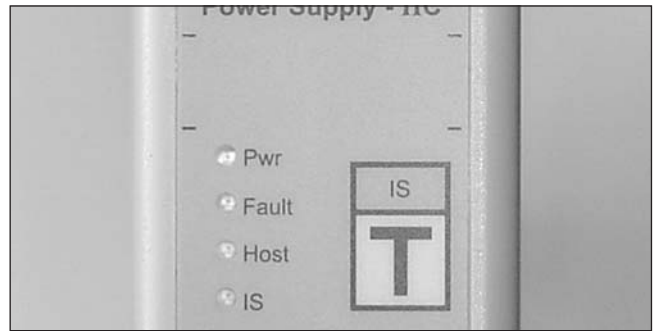

Figure 9 - FISCO power supply tag area and LED's

3.3 TAG LABELLING

Space has been provided on the front label to apply a self-adhesive tag label. The space for a tag label is located above the LED indicators and measures 30mm wide by 9mm high. See Figure 9.

4 MAINTENANCE

IMPORTANT NOTE

If any power supply is suspected of being faulty, return it to Eaton's MTL product line, or the representative from whom it was purchased, for repair or replacement. *DO NOT make repairs or modifications. The safe operation of the unit, and hence the safety of the site, can be affected by unauthorised changes.*

Tests and maintenance checks should be limited to those described in this and the Testing section.

4.1 ROUTINE MAINTENANCE

Check the general condition of the installation occasionally to make sure that no deterioration has occurred. At least once every two years (and more frequently for particularly harsh environments), check that:

- a) power supplies are of the types specified in the relevant documentation;
- b) power supplies and connectors are correctly and legibly tagged, connectors are plugged into the corresponding power supplies and tag details comply with the relevant documentation;
- c) power supplies are securely clipped to the DIN rail;
- d) all cable connections are properly made to the plugs;
- e) all plugs are fully inserted;
- f) all connecting cables are of the specified type and rating; are correctly routed and segregated (particularly when fitted in enclosures) and are not frayed or otherwise damaged;
- g) all cable screens are properly earthed;
- h) there is no sign of damage or corrosion.

If the outer case of a FISCO unit requires cleaning, use a cloth dampened with a dilute mixture of detergent and water. Special care should be taken to ensure that no liquid or debris enters the unit via the ventilation slots.

4.2 ENCLOSURES

The only maintenance needed for enclosures is cleaning and periodic visual inspections. Clean external surfaces only, using soap and water; do not use chemical solvents or proprietary cleaning fluids.

Every year, or more frequently in harsh environments, inspect enclosures and check that they are mounted securely and show no signs of damage that would impair their performance.

Remove any accumulation of water inside (using the drain plug, if fitted). Check cable gland nuts are still tight and that all connections are properly made.

5 ANCILLIARY FIELDBUS EQUIPMENT

This section discusses the use of terminators and spur connectors.

5.1 FIELDBUS TERMINATOR

The FBT1-IS is a DIN rail mounting unit that provides the correct termination for fieldbus circuits in either safe or hazardous areas.

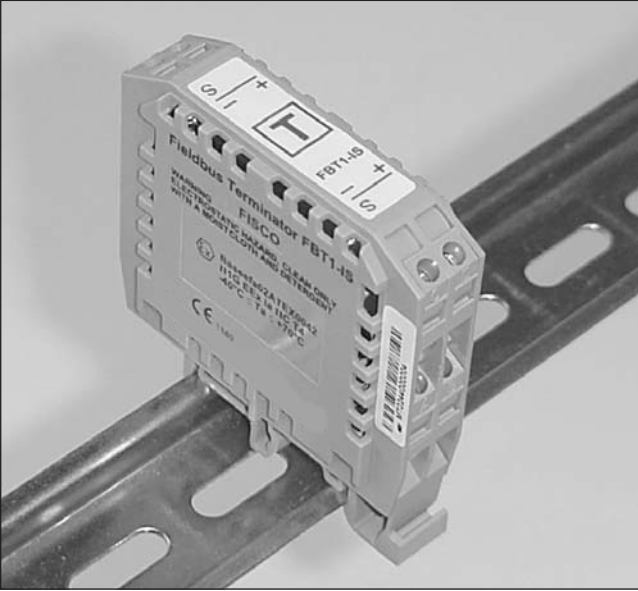

Figure 10 - FBT1-IS fieldbus terminator

The unit is certified for use in Zone 0, IIC, T4 locations, and fully complies with the electrical characteristics requirements of section 22.7.5 of appropriate fieldbus standards. Applicable fieldbus standards and specifications are IEC61158-2, ISA-S50.02 for 31.25kbit/s fieldbus systems and FOUNDATION™ Fieldbus 31.25kbit/s Physical Layer Profile Specification FF816.

Additional information on fieldbus termination can be found in MTL's AB001 and AB002 application briefs.

Terminal assignments and package dimensions are shown in Section 5.3.

5.2 SPUR CONNECTORS

5.2.1 9321-SC Entity spur connector

There may be occasions when a fieldbus Entity certified device is required to be used in a FISCO certified fieldbus system. However, such devices have a certified maximum input power (P_i) of $1.2W$ and a FISCO system has 5.32W of available output power (P_o) and therefore **cannot be connected to the IS fieldbus trunk directly**. See table below.

	FISCO device	Entity cert. device
U_i	= 17.5 V	24 V
I_i	= 380 mA	250 mA
P_i	= 5.32 W	1.2 W
L_i	= 10 mH	20 mH
C_i	= 5 nF	5 nF

The 9321-SC may be used with a 9121-IS repeater/power supply to limit the available power on a spur to an Entity certified device to 1.2W, allowing Entity certified devices to be used in FISCO systems. See Figure 11.

It is also **important** to ensure that the L_i of any Entity device used is $\leq 10\mu H$ to ensure compliance to the FISCO fieldbus standard. However, if $L_i > 10\mu H$, refer to MTL's FISCO Application Note **AN9026** for additional installation requirements.

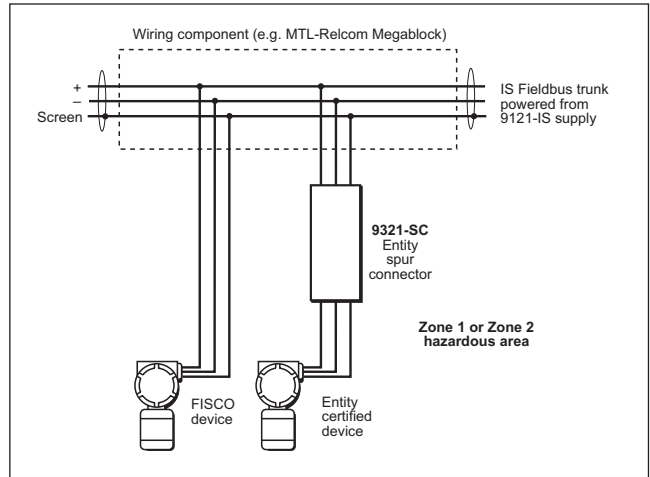

Figure 11 - Connecting an Entity certified device

The 9321-SC is certified EEx ia IIC T4 but when used with a 9121-IS it must be mounted in either a Zone 1 or 2 IIB or IIC T4 hazardous area or a Class 1 Div 1 or 2, gas group A-D, T4 hazardous area, with field wiring also in the same area.

It should be fitted between the IS fieldbus trunk and the field wiring, i.e. typically between a MTL/Relcom Megablock and the field wiring.

It is also recommended that the 9321-SC is used with an IS short-circuit protected Megablock, as this will prevent damage to fuses within the spur connector caused by accidental short-circuiting of spur cable wiring.

Note: The 9321-SC is not suitable for use with a 9122-IS repeater /power supply to connect to an Entity certified device as the input parameters of the Entity certified device would be exceeded.

For Entity-certified field devices connected to segments powered by the 9122-IS FISCO power supply (IIB/C, D), select the 9323-SC spur connector.

5.2.2 9322-SC EEx ia spur connector

The 9322-SC is used to connect a spur from an EEx ib FISCO trunk to a FISCO certified field device mounted in a Zone 0 hazardous area (see Figure 12).

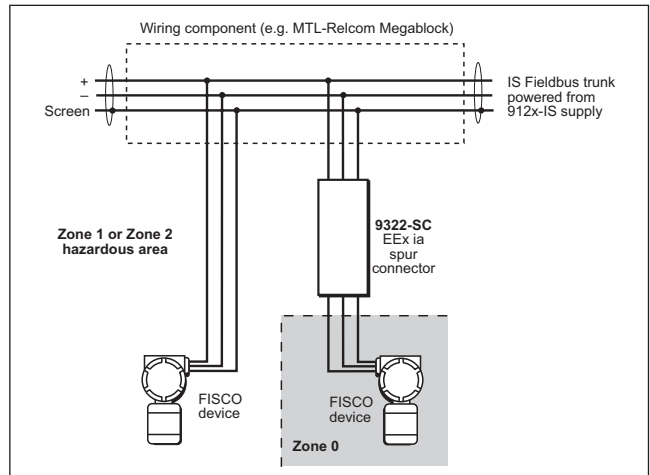

Figure 12 - Connecting to a FISCO device in Zone 0

The 9322-SC is certified EEx ia IIC T4 but when used with a 9122-IS it must be mounted in a Zone 1 or 2, **IIB** T4 hazardous area with field wiring also in the same area.

It should be fitted between the IS fieldbus trunk and field wiring, i.e. typically between an MTL/Relcom Megablock and the field wiring.

It is recommended that the 9322-SC is used with an IS short-circuit protected Megablock, as this will prevent damage to fuses within the 9322-SC caused by accidental short-circuiting of spur cable wiring.

5.2.3 9323-SC Spur Connector-Entity

The 9323-SC may be used with a 9121-IS or 9122-IS repeater/power supply to limit the available power on a spur to an Entity certified device to 1.2W, allowing Entity certified devices to be used in FISCO systems. See Figure 13.

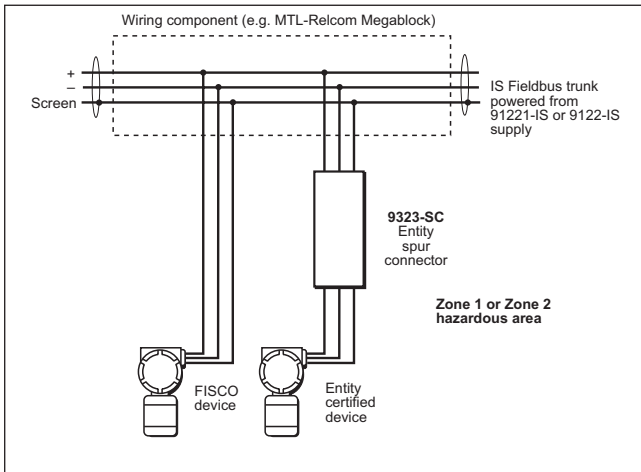

Figure 13 - Connecting an Entity certified device

The 9323-SC is certified EEx ib IIC T4 and when used with a 9121-IS it must be mounted in either a Zone 1 or 2, IIB or IIC, T4 hazardous area or a Class 1, Div 1 or 2, gas group A-D, T4 hazardous area, with field wiring also in the same area. When used with a 9122-IS it must be mounted in a Zone 1 or 2 IIB T4 hazardous area or a Class 1, Div 1 or 2, gas group C-D T4 hazardous area, with field wiring also in the same area. It should be fitted between the IS fieldbus trunk and the field wiring, i.e. typically between a MTL/Relcom Megablock and the field wiring.

The 9323-SC incorporates electronic spur short circuit protection, and may be used with standard or short-circuit protected Megablocks.

Trunk Terminals 1 & 2

- $U_i = 14.8V$
- $I_i = 380mA$
- $P_i = 5.32W$
- $C_i = 0$
- $L_i = 0$

Field Terminals 3 & 4

- $U_o = 14.8V$
- $I_o = 77mA$
- $P_o = 1.15W$
- $C_o = 0.2\mu F$
- $L_o = 2.4mH$

Special Conditions for Safe Use

The Spur Connector-Entity Type 9323-SC has a plastic enclosure and must only be cleaned with a damp cloth to avoid the danger of ignition due to a build-up of an electrostatic charge.

5.3 MOUNTING AND CONNECTION

5.3.1 Package details

The FBT1-IS terminator and the 932x-IS spur connectors use the same style of package (see Figure 14) which is designed for mounting on 35 x 7.5 mm or 35 x 15 mm DIN rail to EN50022.

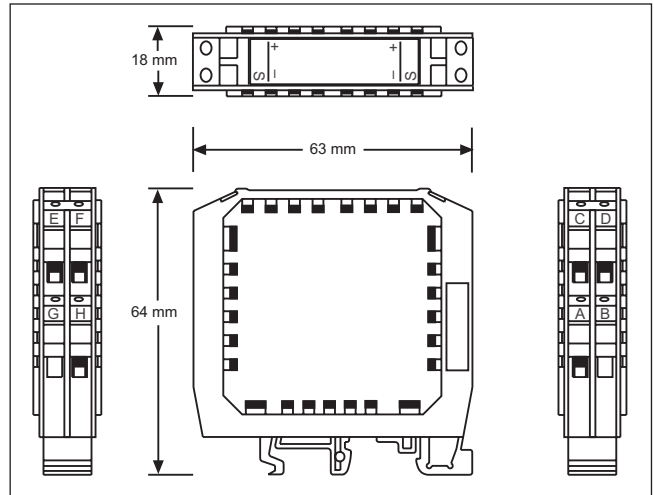

Figure 14 - Terminator/Spur connector package

5.3.2 Fitting

Orientate the package as shown in Figure 15a and locate it on the DIN rail. Using the DIN rail edge as the pivot point, press down the other end until the package clicks into place on the other side of the rail.

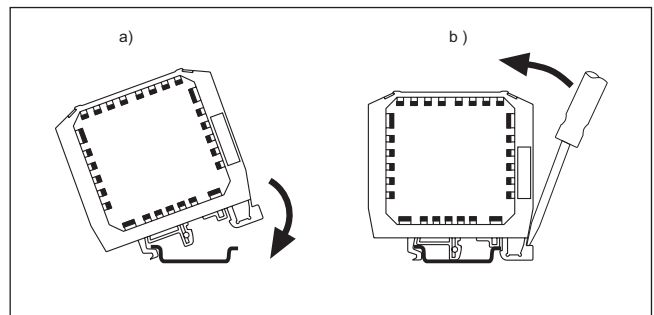

Figure 15 - a) fitting and b) removal

5.3.3 Removal

Removal requires a screwdriver or similar flat blade. Locate the screwdriver into the slot provided in the fixing bracket on the 'device' side of the spur connector (see Figure 15b). Carefully lever towards the spur connector body until the mounting is released from the DIN rail and lift it off the rail.

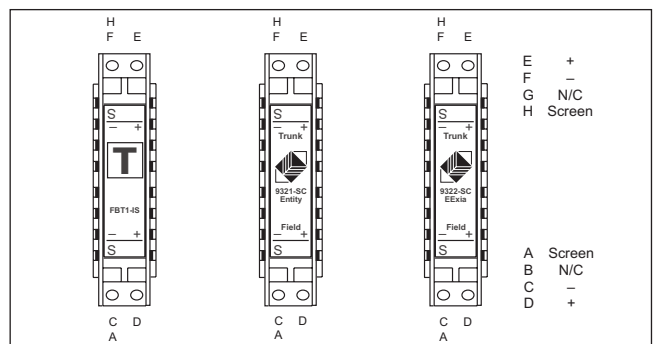

Figure 16 - Terminal assignments

5.3.4 Connections

The +, - and cable screen (S) connections are indicated in Figure 16. The terminals will accept cables with a cross sectional area of up to 4 mm². A straight blade screwdriver with a maximum blade width of 3.5 mm is required to operate the terminals. The recommended tightening torque is <0.9 Nm.

6 APPENDIX A - ATEX INFORMATION

The Essential Health and Safety Requirements (Annex II) of the EU Directive 2014/34/EU [the ATEX Directive - safety of apparatus] requires that the installation manual of all equipment used in hazardous areas shall contain certain information. This annex is included to ensure that this requirement is met. It compliments the information presented in this document and does not conflict with that information. It is only relevant to those locations where the ATEX directives are applicable.

6.1 General

- a) In common with all other electrical apparatus installed in hazardous areas, this apparatus must only be installed, operated and maintained by competent personnel. Such personnel shall have undergone training, which included instruction on the various types of protection and installation practices, the relevant rules and regulations, and on the general principles of area classification. Appropriate refresher training shall be given on a regular basis. [See clause 4.2 of EN 60079-17].
- b) The apparatus has been designed and manufactured to satisfy the "essential health and safety requirements" of Annex II of the Directive.

6.1.1 9121-IS and 9122-IS only

- a) This apparatus has been designed to meet the requirements of associated electrical apparatus in accordance with EN 50020 and EN50014.
- b) This apparatus also meets the requirements of protection 'n' in accordance with EN 50021.

6.1.2 FBT1-IS, 9321-SC, 9322-SC and 9323-SC only

- a) This apparatus has been designed to meet the requirements of I.S. electrical apparatus in accordance with EN 50020 and EN50014 and is normally mounted in the hazardous area.
- b) This apparatus requires additional protection for use in dust environments.

6.2 Installation

- a) The installation should comply with the appropriate European, national and local regulations, which may include reference to the IEC code of practice IEC 60079-14. In addition particular industries or end users may have specific requirements relating to the safety of their installations and these requirements should also be met. For the majority of installations the Directive 1999/92/EC [the ATEX Directive - safety of installations] is also applicable.
- b) The apparatus must not be subjected to mechanical and thermal stresses in excess of those permitted in the certification documentation, this manual and the product specification. If necessary the product must be protected by an enclosure to prevent mechanical damage.

- c) The apparatus must not be installed in a position where it may be attacked by aggressive substances and must be protected from excessive dust, moisture and other contaminants by an enclosure.

6.2.1 9121-IS and 9122-IS only

- a) This apparatus is an associated electrical apparatus and is normally mounted in a non-hazardous [safe] area. It meets the requirements of Category 3 apparatus and may be installed in a Zone 2 location providing that the relevant installation conditions are met. When mounted in a Zone 1 location the apparatus must be provided with an enclosure, which offers an additional degree of protection appropriate to the area classification.

6.2.2 FBT1-IS, 9321-SC and 9322-SC only

- a) This apparatus is I.S. electrical apparatus and is normally mounted in a hazardous area. It meets the requirements of Category 1 apparatus and may be installed in a Zone 0 location providing that the relevant installation conditions are met.

6.2.3 9323-SC only

This apparatus is I.S. electrical apparatus and is normally mounted in a hazardous area. It meets the requirements of Category 2 apparatus and may be installed in a Zone 1 location providing that the relevant installation conditions are met.

6.3 Inspection and maintenance

- a) Inspection and maintenance should be carried out in accordance with European, national and local regulations which may refer to the IEC standard IEC 60079-17. In addition specific industries or end users may have specific requirements which should also be met.
- b) Access to the internal circuitry must not be made during operation.
- c) If the outer enclosure of the apparatus needs to be cleaned, this should be done with a cloth lightly moistened by a dilute mixture of detergent in water.

6.4 Repair

- a) The products cannot be repaired by the user and must be replaced with an equivalent certified product. Repairs should only be carried out by the manufacturer or his authorised agent.

6.5 Marking

- a) The products each have their own labels which are reproduced below. In addition the serial number and/or date of manufacture are marked on the individual apparatus. This manual applies to products manufactured and date marked during or after the year 2003 .

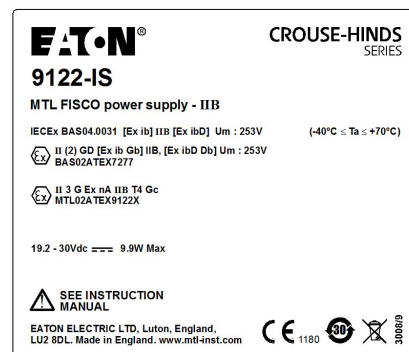
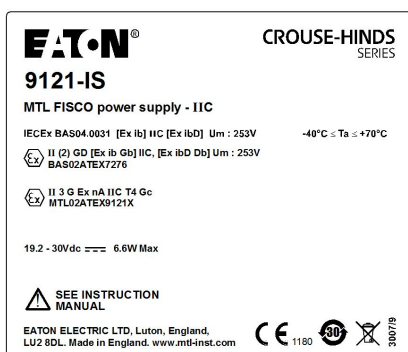



EATON CROUSE-HINDS SERIES

FISCO



9321-SC MTL entity spur connector

 **Baseefa03ATEX0108X**
II 1 G Ex ia IIC T4 Ga
-40°C ≤ Ta ≤ +70°C

3126/4



 1180

WARNING
 ELECTROSTATIC HAZARD, CLEAN ONLY
 WITH A MOISTCLOTH AND DETERGENT
 EATON ELECTRIC LTD, Luton, England,
 LU2 8DL. Made in India. www.mtl-inst.com



EATON CROUSE-HINDS SERIES

FISCO



9321-SC MTL entity spur connector

 **Baseefa03ATEX0108X**
II 1 G Ex ia IIC T4 Ga
-40°C ≤ Ta ≤ +70°C

3126/4



 1180

WARNING
 ELECTROSTATIC HAZARD, CLEAN ONLY
 WITH A MOISTCLOTH AND DETERGENT
 EATON ELECTRIC LTD, Luton, England,
 LU2 8DL. Made in India. www.mtl-inst.com

This page left intentionally blank

This page left intentionally blank

This page left intentionally blank

AUSTRALIA

MTL Instruments Pty Ltd,
10 Kent Road, Mascot, New South Wales, 2020, Australia
Tel: +61 1300 308 374 Fax: +61 1300 308 463
E-mail: mtl-salesanz@eaton.com

BeNeLux

MTL Instruments BV
Ambacht 6, 5301 KW Zaltbommel
The Netherlands
Tel: +31 (0)418 570290 Fax: +31 (0)418 541044
E-mail: mtl.benelux@eaton.com

CHINA

Cooper Electric (Shanghai) Co. Ltd
955 Shengli Road, Heqing Industrial Park
Pudong New Area, Shanghai 201201
Tel: +86 21 2899 3817 Fax: +86 21 2899 3992
E-mail: mtl-cn@eaton.com

FRANCE

MTL Instruments sarl,
7 rue des Rosiéristes, 69410 Champagne au Mont d'Or
France
Tel: +33 (0)4 37 46 16 53 Fax: +33 (0)4 37 46 17 20
E-mail: mtlfrance@eaton.com

GERMANY

MTL Instruments GmbH,
Heinrich-Hertz-Str. 12, 50170 Kerpen, Germany
Tel: +49 (0)22 73 98 12-0 Fax: +49 (0)22 73 98 12-2 00
E-mail: csckerpen@eaton.com

INDIA

MTL India,
No.36, Nehru Street, Off Old Mahabalipuram Road
Sholinganallur, Chennai- 600 119, India
Tel: +91 (0) 44 24501660 /24501857 Fax: +91 (0) 44 24501463
E-mail: mtlindiasales@eaton.com

ITALY

MTL Italia srl,
Via San Bovio, 3, 20090 Segrate, Milano, Italy
Tel: +39 02 959501 Fax: +39 02 95950759
E-mail: chmninfo@eaton.com

JAPAN

Cooper Crouse-Hinds Japan KK,
MT Building 3F, 2-7-5 Shiba Daimon, Minato-ku,
Tokyo, Japan 105-0012
Tel: +81 (0)3 6430 3128 Fax: +81 (0)3 6430 3129
E-mail: mtl-jp@eaton.com

NORWAY

Norex AS
Fekjan 7c, Postboks 147,
N-1378 Nesbru, Norway
Tel: +47 66 77 43 80 Fax: +47 66 84 55 33
E-mail: info@norex.no

RUSSIA

Cooper Industries Russia LLC
Elektrozavodskaya Str 33
Building 4
Moscow 107076, Russia
Tel: +7 (495) 981 3770 Fax: +7 (495) 981 3771
E-mail: mtlrussia@eaton.com

SINGAPORE

Cooper Crouse-Hinds Pte Ltd
No 2 Serangoon North Avenue 5, #06-01 Fu Yu Building
Singapore 554911
Tel: +65 6645 9864 / 6645 9865 Fax: +65 6 487 7997
E-mail: sales.mtlsing@eaton.com

SOUTH KOREA

Cooper Crouse-Hinds Korea
7F, Parkland Building 237-11 Nonhyun-dong Gangnam-gu,
Seoul 135-546, South Korea.
Tel: +82 6380 4805 Fax: +82 6380 4839
E-mail: mtl-korea@eaton.com

UNITED ARAB EMIRATES

Cooper Industries/Eaton Corporation
Office 205/206, 2nd Floor SJ Towers, off. Old Airport Road,
Abu Dhabi, United Arab Emirates
Tel: +971 2 44 66 840 Fax: +971 2 44 66 841
E-mail: mtlgulf@eaton.com

UNITED KINGDOM

Eaton Electric Ltd,
Great Marlings, Butterfield, Luton
Beds LU2 8DL
Tel: +44 (0)1582 723633 Fax: +44 (0)1582 422283
E-mail: mtlenquiry@eaton.com

AMERICAS

Cooper Crouse-Hinds MTL Inc.
3413 N. Sam Houston Parkway W.
Suite 200, Houston TX 77086, USA
Tel: +1 281-571-8065 Fax: +1 281-571-8069
E-mail: mtl-us-info@eaton.com